



MAIN UNIT

WALL MOUNT



FOR:

- DRAGON
- SHOCKWAVE WIRELESS

Owner's Manual

IMPORTANT SAFETY INSTRUCTIONS

Nakamichi wall mounts are designed and manufactured to function within defined design limits. Incorrect installation or misuse may result in product damage or injury. To prevent Nakamichi wall mounts from being damaged, the following rules should be observed during installation, use and maintenance. Please read the following safety instructions before operating. Nakamichi LLC shall bear no responsibility for any damage or injury resulting from incorrect installation, assembly or misuse. Keep these instructions in a safe place for future reference.

- Read, keep and follow all instructions.
- Do not overload the wall mount. Refer to package contents page for the maximum load of the wall mount.
- The instruction manual covers standard residential drywall installation. For concrete wall installation, seek professional assistance.
- As per article 400.8 in the NEC (National Electrical Code), do not run power cables (including ones supplied with the system) through a wall as a substitute for permanent wiring, i.e. wired outlets.
- Clean only with a dry cloth.
- Do not block any hardware component ventilation openings.
- Do not install near any heat sources such as radiators, heat registers, stoves, or other apparatus that produce heat.
- Protect the power cord from being walked on or pinched, particularly at plugs, convenience receptacles, and the point where they exit from the wall mounts.
- Do not install the wall mounts in an area with heavy dust or high humidity. Operating the system in environments with heavy dust or high humidity may cause fire or electric shock.
- Ensure that the power cord and any other cables are unplugged before moving the system.
- To prevent injury, the wall mounts must be securely attached to the wall in accordance with the installation instructions.



This wall mount is intended for use only with Nakamichi DRAGON Main Unit and Shockwafe Wireless soundbar.

1

Package Contents

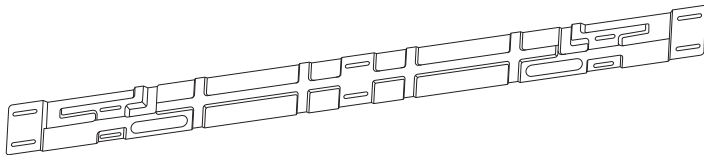

Wall Mount Plate x 1

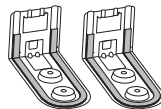

L-Shaped Wall Mount Brackets x 2

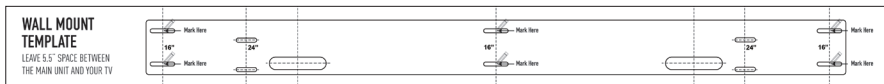

Wall Mount Template x 1



25mm / 0.98"

Wall Mount Anchors x 6
(2 anchors are extra)

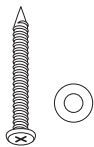

#7 x 2"

Wall Mount Screws (2")
w/ Washer x 10



Mounting Screws x 4



The wall mount is engineered to support a unit weighing up to 60 pounds when securely anchored to all 6 wall studs.

Wall mounting template may look like packaging material. Do not discard. Before starting assembly, verify all parts are included and undamaged. If any part is missing or damaged, contact Nakamichi's Customer Service. Never use damaged parts!

1 Package Contents

Tools required for installation (not included):

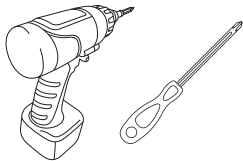

Power Drill or equivalent

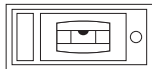

Leveler

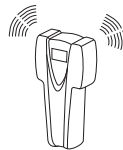

Stud Finder

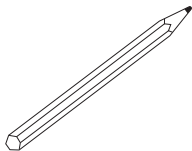

Pencil



Masking Tape

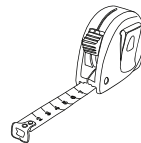

Measuring Tape

2A Installation

Locate the wall studs using a stud finder. Mark the center of each stud using a pencil.

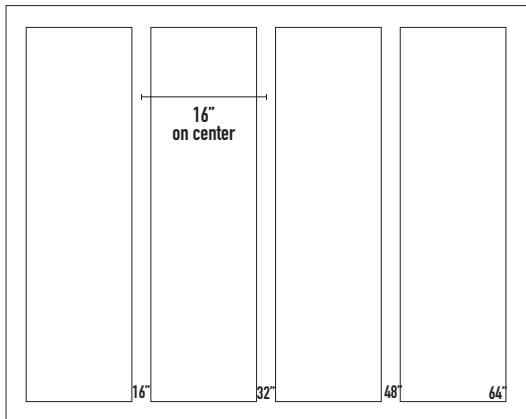

Example of Wood Stud Wall

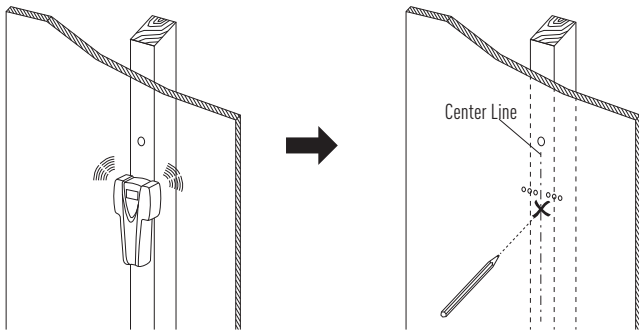

The wall mount is compatible with the wall studs that are spaced 16 or 24 inches apart. For optimal support, secure the wall mount to wood studs. If you are unfamiliar with installation, seek professional assistance.

2B Installation

Position Wall Mount Template such that the center lines of screw holes are aligned with the wood studs.

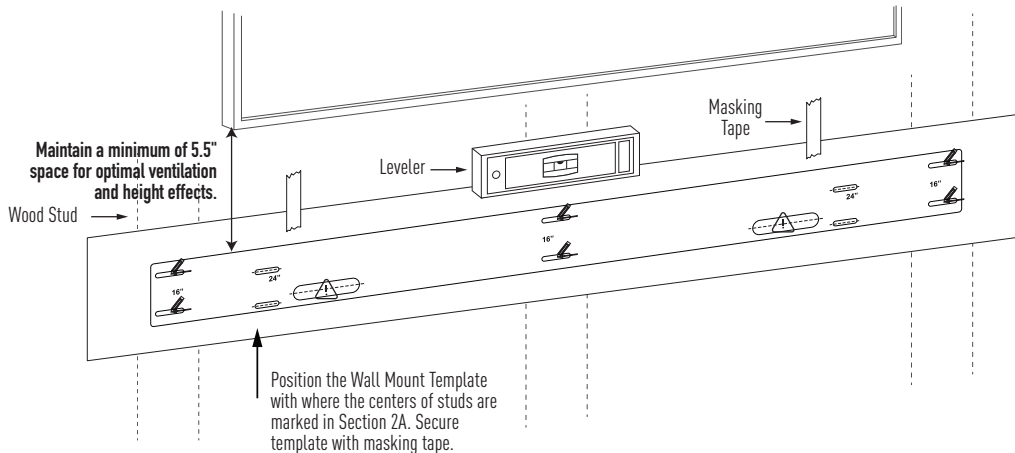

 Use a measuring tape to ensure that the main unit is mounted at desired height. Ensure there is at least a 5.5 inch gap between the TV and the main unit to ensure optimal ventilation and height effects.

 **Cable Management Tip:** Mark the designated spot  if you are planning to create a hole to run  inside the wall. Use in-wall certified HDMI cables only; the Nakamichi HDMI cable is not suitable for this purpose. As per article 400.8 in the NEC (National Electrical Code), do not run power cables (including ones supplied with the main unit) through a wall as a substitute for permanent wiring, i.e. wired outlets.

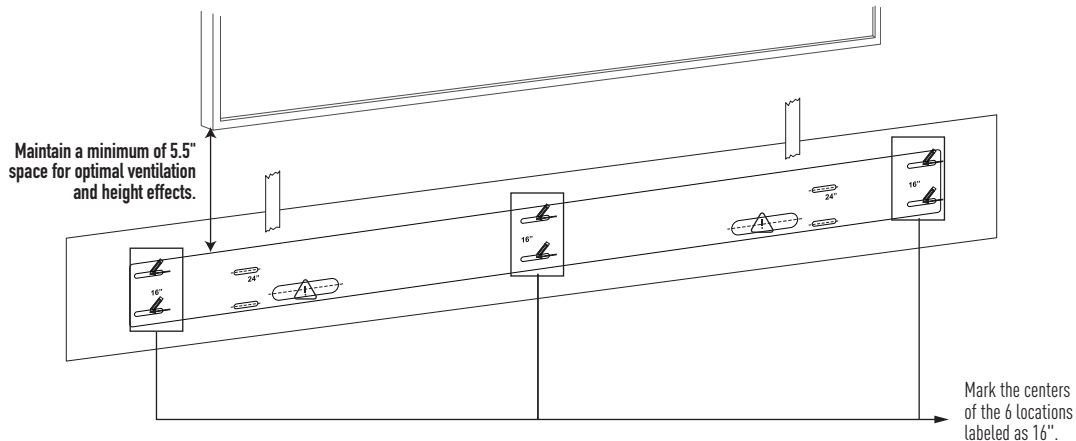

2B Installation



Ensure there is at least a 5.5 inch gap between the TV and the main unit to ensure optimal ventilation and height effects.



Cable Management Tip:

Mark the designated spot  if you are planning to create a hole to run  inside the wall. Use in-wall certified HDMI cables only; the Nakamichi HDMI cable is not suitable for this purpose. As per article 400.8 in the NEC (National Electrical Code), do not run power cables (including ones supplied with the system) through a wall as a substitute for permanent wiring, i.e. wired outlets.

2B

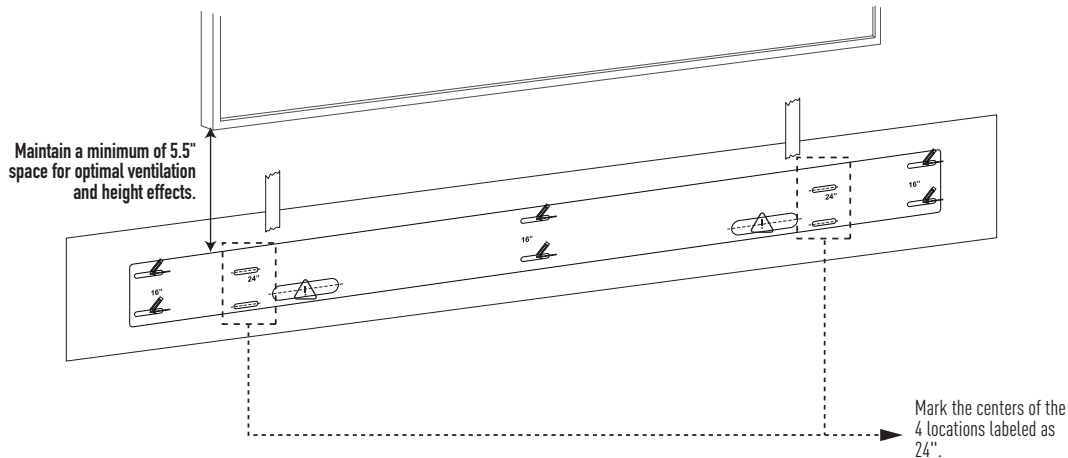

Installation



Ensure there is at least a 5.5 inch gap between the TV and the main unit to ensure optimal ventilation and height effects.



Cable Management Tip:



Mark the designated spot  if you are planning to create a hole to run  inside the wall. Use in-wall certified HDMI cables only; the Nakamichi HDMI cable is not suitable for this purpose. As per article 400.8 in the NEC (National Electrical Code), do not run power cables (including ones supplied with the system) through a wall as a substitute for permanent wiring, i.e. wired outlets.

2C Installation

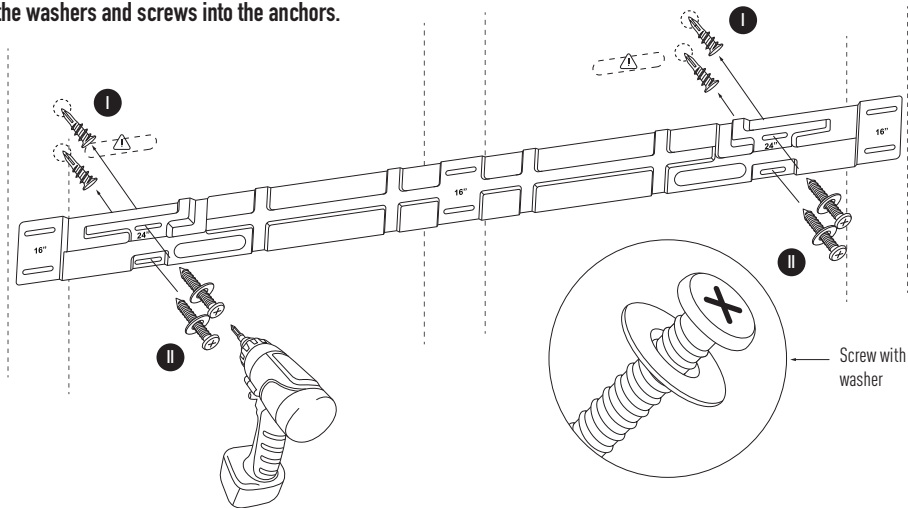
- ❶ Drill, then firmly insert the 4 anchors into the wall positions indicated in Section 2B labeled as 24" on the Wall Mount Template.
- ❷ Securely fasten the washers and screws into the anchors.



Cable Management Tip:

Mark the designated spot  if you are planning to create a hole to run  inside the wall. Use in-wall certified HDMI cables only; the Nakamichi HDMI cable is not suitable for this purpose. As per article 400.8 in the NEC (National Electrical Code), do not run power cables (including ones supplied with the system) through a wall as a substitute for permanent wiring, i.e. wired outlets.

2D Installation

Securely affix the Wall Mount Plate using screws with washers through the provided openings.

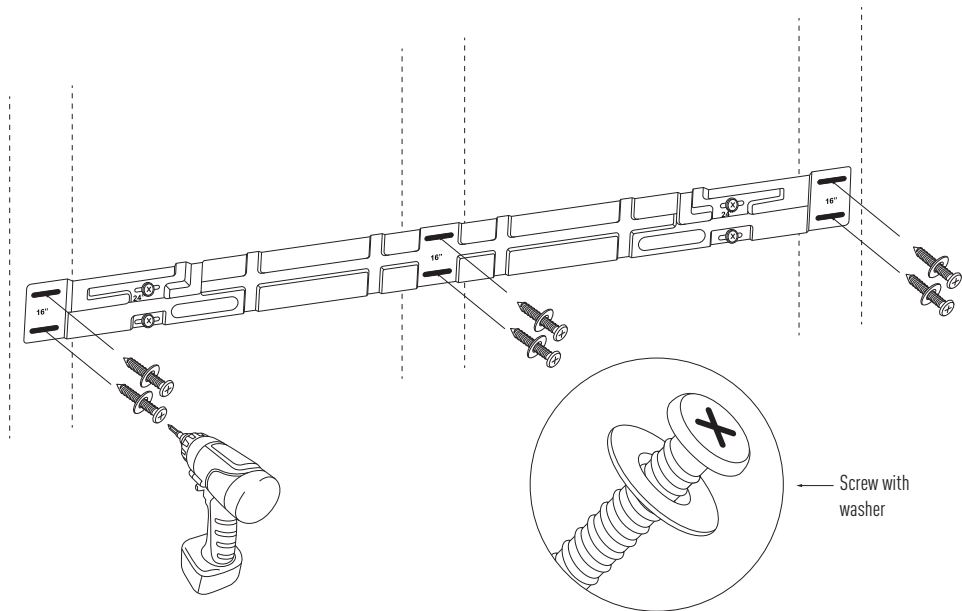

2E Installation

Attach the Wall Mount Brackets onto the Wall Mount Plate.

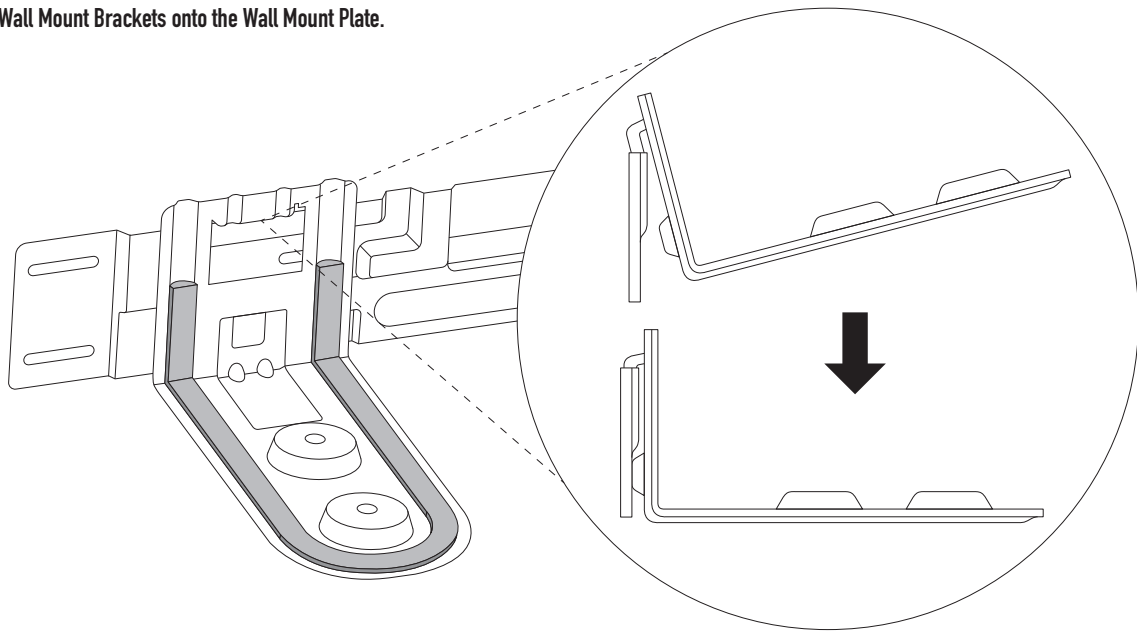

2F Installation—for Shockwafe Wireless

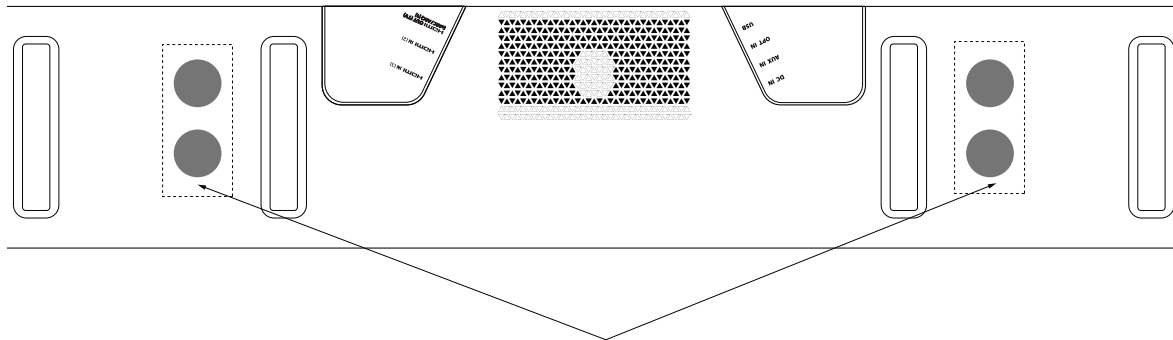

Locate a smooth, spacious and leveled surface area that is both long and wide enough to accommodate the soundbar. Place the provided cover cloth on the surface. Then, flip the soundbar upside down to access its bottom with the cover cloth underneath it to protect it from scratches.

Remove the 4 circular rubber pads from the bottom of the soundbar using a tool with a pointed tip.

2F Installation—for Shockwafe Wireless

Align the circular indents on the Wall Mount Brackets with the holes on the bottom of the soundbar. Securely fasten the 4 mounting screws from the bottom.

SOUNDBAR

TEAM
LIFTING
REQUIRED
(OVER 31 LBS)



Ensure that 2 people lift the soundbar onto the Wall Mount Brackets.

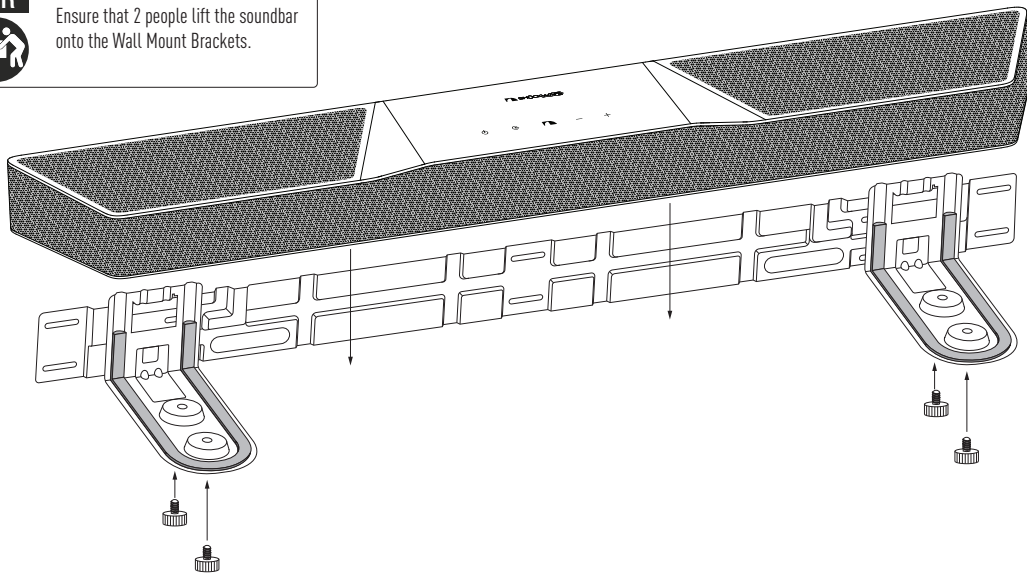

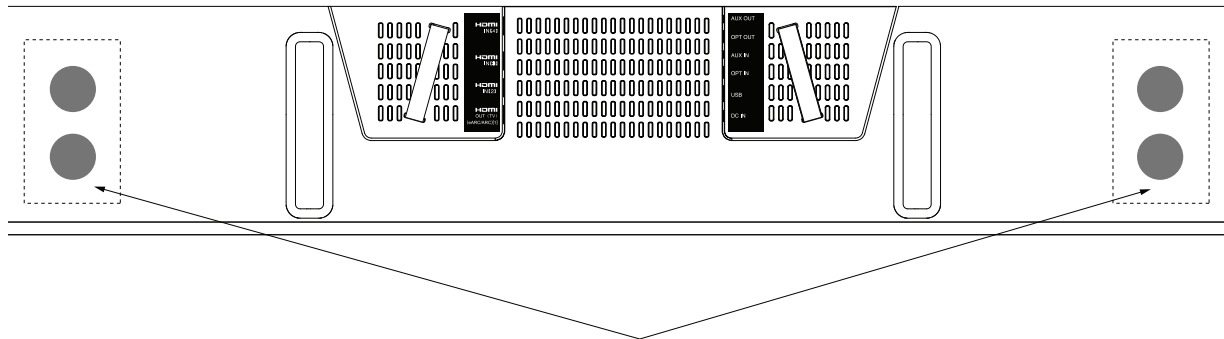

Locate a smooth, spacious and leveled surface area that is both long and wide enough to accommodate the main unit. Place the provided cover cloth on the surface. Then, flip the main unit upside down to access its bottom with the cover cloth underneath it to protect it from scratches.

Remove the 4 circular rubber pads from the bottom of the main unit using a tool with a pointed tip.

2G Installation-for DRAGON

Align the circular indents on the Wall Mount Brackets with the holes on the bottom of the main unit. Securely fasten the 4 mounting screws from the bottom.

MAIN UNIT

TEAM
LIFTING
REQUIRED
(OVER 32 LBS)



Ensure that 2 people lift the main unit onto the Wall Mount Brackets.

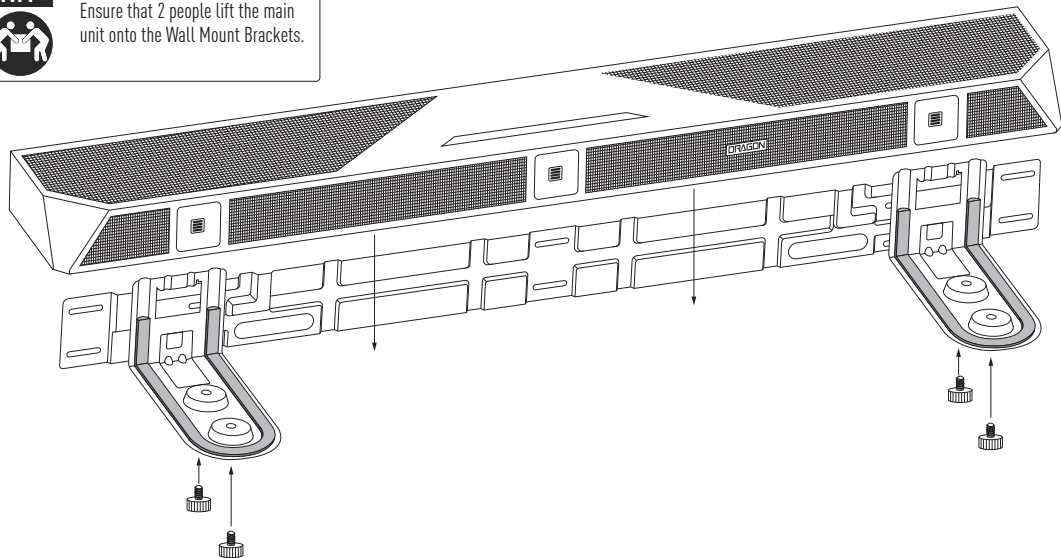

2G Installation-for DRAGON

Establish the necessary connections based on your personal device configuration.

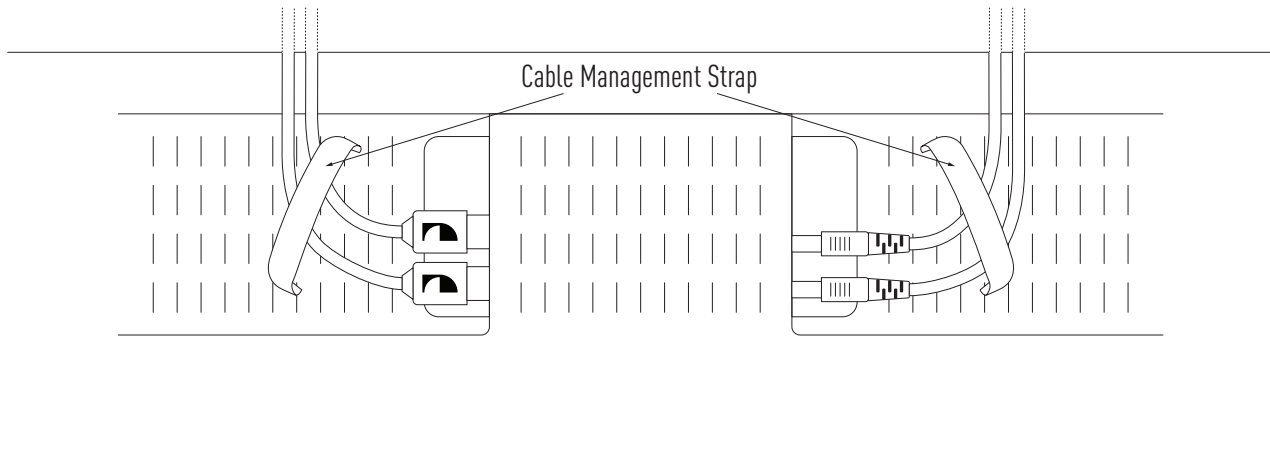

Bottom view

3 Warranty Information

LIMITED WARRANTY (U.S. Only)

Nakamichi LLC, maker of Nakamichi® branded products ("Nakamichi"), provides the following limited warranty for certain Nakamichi products ("Product(s)") to the original purchaser. This warranty assures that Products will be free from defects in material and workmanship under normal use during the Applicable Warranty Period(s) listed below, which starts from the date of original purchase. To avail of this limited warranty, the Products must be purchased from Nakamichi or an authorized seller, as permitted by law. Only authorized sellers, following Nakamichi's policies, procedures, and quality control standards, legitimately sell Nakamichi Products. Warranty claims from purchasers who bought Products from unauthorized sellers, including unauthorized Internet sites, may be rejected by Nakamichi.

What We Will Do:

In the event of a valid warranty claim after investigation by Nakamichi, we will replace any defective Product part free of charge.

Warranty Period:

This Nakamichi Product is covered by a five (5) years of limited warranty.

How to Get Warranty Service:

For warranty service, purchasers with a Product defect claim should call Nakamichi at 1-415-888-9626. We will discuss the issue with you, and upon confirming that the Product is under warranty, replacement parts will be dispatched to you at no cost. However, please note that the costs associated with removing and replacing defective parts from your Nakamichi Product are not covered by this limited warranty. If a repair technician is required, you will be responsible for any labor charges incurred.

Additional Exclusions:

Normal wear and tear, damage due to misuse, alterations to the Product, negligence, or any modification made to your Nakamichi Product will render this limited warranty void. Improper installation, exceeding the stated weight capacity, or any form of misuse or abuse will also void this warranty. Nakamichi Products are designed solely for indoor use, and any outdoor use will nullify this limited warranty unless explicitly marked for outdoor use by Nakamichi. As per article 400.8 in the NEC (National Electrical Code), do not run power cables (including ones supplied with the system) through a wall as a substitute for permanent wiring, i.e. wired outlets. Additionally, the limited warranty for wall mounts becomes void if the mount is relocated from its initial installation.

3 Warranty Information

Nakamichi LLC intends to make this manual accurate and complete. However, Nakamichi LLC makes no claim that the information contained herein covers all details, conditions, or variations. Nor does it provide for every possible contingency in connection with the installation or use of this product. The information contained in this document is subject to change without notice or obligation of any kind. Nakamichi LLC makes no representation of warranty, expressed or implied, regarding the information contained herein. Nakamichi LLC assumes no responsibility for the accuracy, completeness, or sufficiency of the information contained in this document.

Limitation of Liability:

This limited warranty represents the extent of warranties provided for Nakamichi Products. Any applicable implied warranties, including implied warranties of merchantability or fitness for a particular purpose, are limited to the duration of this warranty. Some states do not allow limitations on how long an implied warranty lasts, so the above limitation may not apply to you. Nakamichi shall not be liable for any special, incidental, or consequential damages (e.g., cost of repairing or replacing other property which may be damaged when the Product does not work properly) arising from breach of this limited warranty, breach of contract, or strict liability. Some states do not allow the exclusion or limitation of incidental or consequential damages, so the above limitation or exclusion may not apply to you. This warranty provides you with specific legal rights, and you may have other rights that vary from state to state.

NAKAMICHI CONCIERGE

Should you need any assistance, please contact us.

 : +1 (415) 888 9626

 : support@nakamichi-usa.com

Operating Hours

- 10AM to 6:45PM PST Weekdays
- 10AM to 4:45PM PST Saturday

VIDEO INSTRUCTIONS

bit.ly/main-unit-mount-installation



NAKAMICHI CONCIERGE BASED IN CALIFORNIA



support@nakamichi-usa.com



+1 (415) 888 9626



(Weekdays 10am - 6:45pm PST; Saturday 10am - 4:45pm PST)

NAKAMICHI LLC. ALL RIGHTS RESERVED.